



PW50 Portable Workboard 4 inch Thermal Receipt Printer

Base Configuration: Workboard printer with Bluetooth, DEX, and serial.

Included in Box: Printer, Quick Start Guide, Warranty Card

Required Accessories: Battery, Battery charging devices for portable application, media

CN3 and CN3E use the same holder

Solution Guide

Name	Part Number	Description
<p>PW50 CN3/CN3E</p> 	<p>PW50A010101</p>	<p>PW50A for CN3/CN3E, ESC-P, Bluetooth, DEX, with MSR/SCR (Must order Battery Pack separately for portable application).</p>
<p>PW50 CN3/CN3E</p> 	<p>PW50A010102</p>	<p>PW50A for CN3/CN3E, ESC-P, Bluetooth, DEX, No MSR/SCR (Must order Battery Pack separately for portable application).</p>
<p>PW50 CK61 with MSR</p> 	<p>PW50A020101</p>	<p>PW50A for CK61, ESC-P, Bluetooth, DEX, with MSR/SCR (Must order Battery Pack separately for portable application).</p>
<p>Printer PW50 CK61 no MSR</p> 	<p>PW50A020102</p>	<p>PW50A for CK61, ESC-P, Bluetooth, DEX, No MSR/SCR (Must order Battery Pack separately for portable application).</p>

<p>Battery Pack</p> 	<p>318-026-001</p>	<p>High capacity rechargeable Li-ion battery (14.8V, 2200mAh) 4 cell; 32.56 watt hours.</p>
<p>Power Supply</p> 	<p>851-082-003 or 851-082-103 or 851-082-105</p>	<p>Universal Power Supply, 12VDC 50W FW5012 (Order country specific AC power cord separately). 851-082-103 ST 851-082-105 RA</p> <p><u>Printer connector:</u> ST = Straight DC Jack RA = Right Angle DC Jack</p>
<p>Power Cord</p> 	<p>1-974029-020 1-974027-025 586276 321-471-002 321-501-002 321-502-002</p>	<p>Power Cord 220-250 VAC, UK Power Cord 220-250 VAC, Europe Power Cord 220-230 VAC, Liechtenstein, Switzerland Power Cord 120-250 VAC, Italy Power Cord 220-250 VAC, Denmark, Greenland Power Cord 250 VAC, India/S Africa</p>
<p>Battery Charger</p> 	<p>852-915-001</p>	<p>4-Bay Battery Charger (Requires A/C adapter p/n 851-082-003 or 851-082-103 or 851-082-105).</p>



Country AC Power Cord

851-082-003
Or
851-082-105

318-026-001





Country AC Power Cord

851-082-003 ST
Or
851-082-105 RA



852-915-001

318-026-001





Carrying Options

Name	Part Number	Description
<p>PW50 Handstrap</p> 	<p>825-196-001</p>	<p>Nylon handstrap that is installed on the either side. (This is NOT the same as PB50 handstrap).</p>
<p>PW50 Shoulder Strap</p> 	<p>074788-001</p>	<p>PW50 Shoulder Strap</p>

To attach the shoulder strap to the PW50

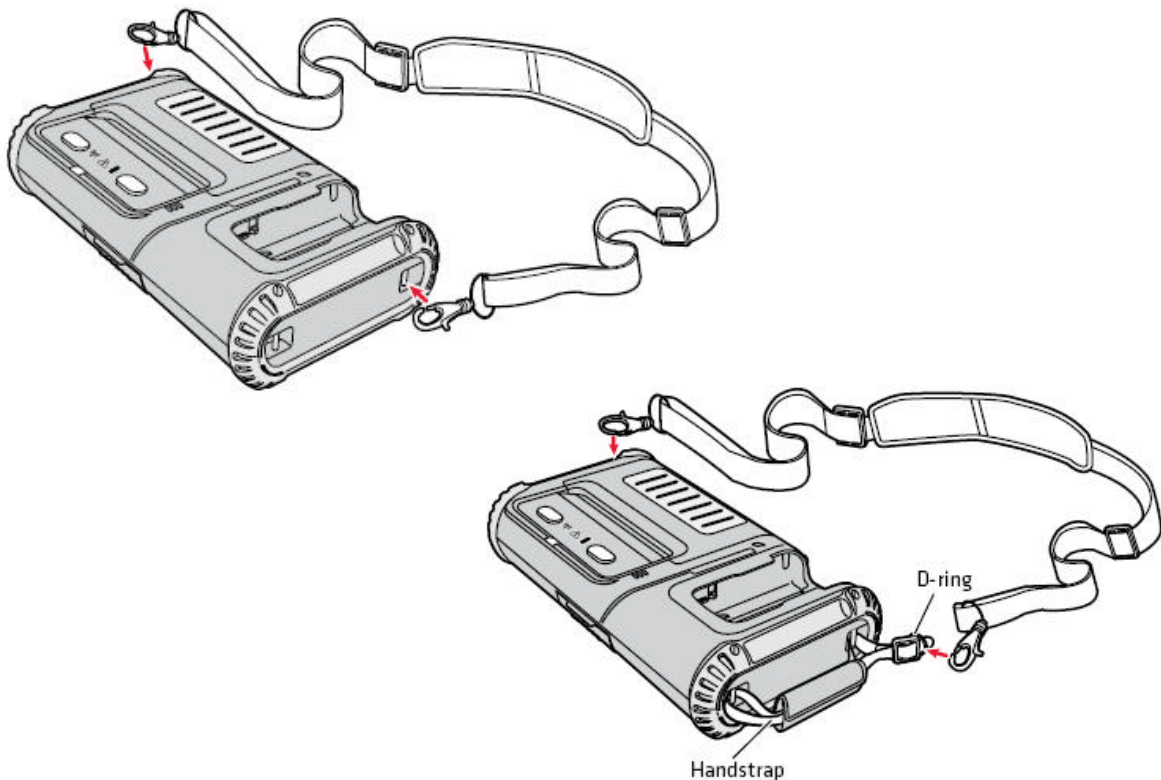
- 1 Orient the shoulder strap so that the textured side of the strap padding is facing toward the printer.
- 2 Attach the snap hooks directly to the PW50, or if you have a handstrap installed, attach the snap hooks to the D-ring on the handstrap.



Vehicle Mounting Options

The vehicle cradle provides a convenient way to mount the PW50 to your vehicle for charging or printing.

Included in the box

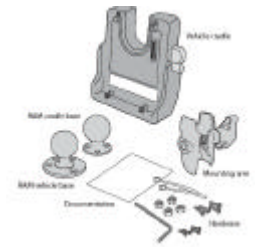

The vehicle dock has an arm that swivels over the top of the handheld to hold it in place in case of an accident. For this reason, the CN3, CN3E, and CK61 all have slightly different vehicle mounts.

You need to add power cable.

Name	Part Number	Description
<p>Vehicle Mount CN3</p> 	<p>225-749-001 <i>Available Q3 2008</i></p>	<p>Vehicle Mount PW50+CN3. You need to add power cable.</p>
<p>Vehicle Mount CN3E</p> 	<p>225-750-001 <i>Available Q3 2008</i></p>	<p>Vehicle Mount PW50+CN3E. You need to add power cable.</p>
<p>Vehicle Mount CK61</p> 	<p>225-751-001 <i>Available Q3 2008</i></p>	<p>Vehicle Mount PW50+CK61. You need to add power cable.</p>

PW50

Solution
Guide

Typical Vehicle Mounting (not Forklift)

(typical vehicle installation uses 2 cables)

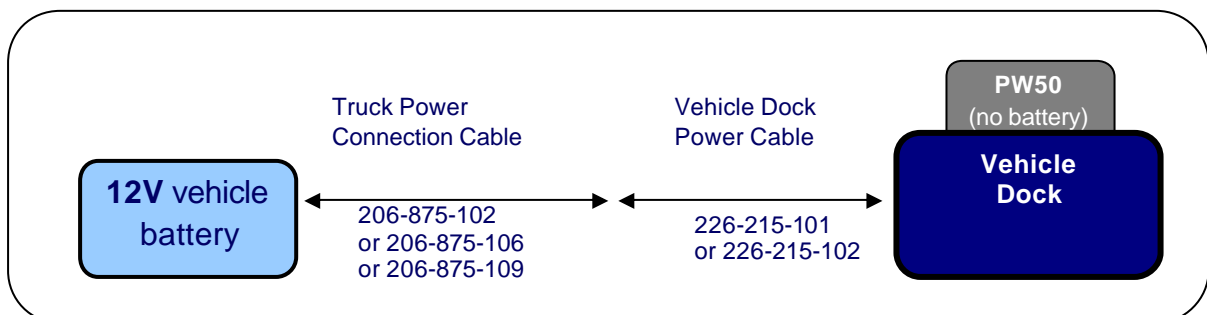

Name	Part Number	Description
Vehicle Dock Power Cable (S) 	226-215-101	Cable DC power 4' (between Vehicle dock and Truck Power Connection Cable). <u>Printer connector:</u> Straight angle Plug: 226-215-101
Vehicle Dock Power Cable (R) 	226-215-102	Cable DC Power (between Vehicle dock and Truck Power Connection Cable). <u>Printer connector:</u> Right angle Plug: 226-215-102
Truck Power Connection Cable 	206-875-102 206-875-106 206-875-109	Cable between Vehicle Dock Power Cable and truck battery <u>Truck Power Cables length</u> 206-875-102 = 2,43m (8') 206-875-106 = 4,87m (16') 206-875-109 = 6,71m (22')



PW50

Solution Guide

Alternate Vehicle Mounting (not Forklift) (typical vehicle installation uses 2 cables)

Name	Part Number	Description
Vehicle Power to DC Jack Cable 	852-909-001	Cable between PW50 printer DC jack and Truck Power Connection Cable
Cigarette Lighter to DC Jack Cable 	074866	Cigarette Lighter Adapter. Cable between PW50 and cigarette lighter.
Truck Power Connection Cable 	206-875-102 206-875-106 206-875-109	Cable between Vehicle Dock Power Cable and truck battery <u>Truck Power Cables length</u> 206-875-102 = 8' (2,4m) 206-875-106 = 16' (4,8m) 206-875-109 = 22' (6,7m)

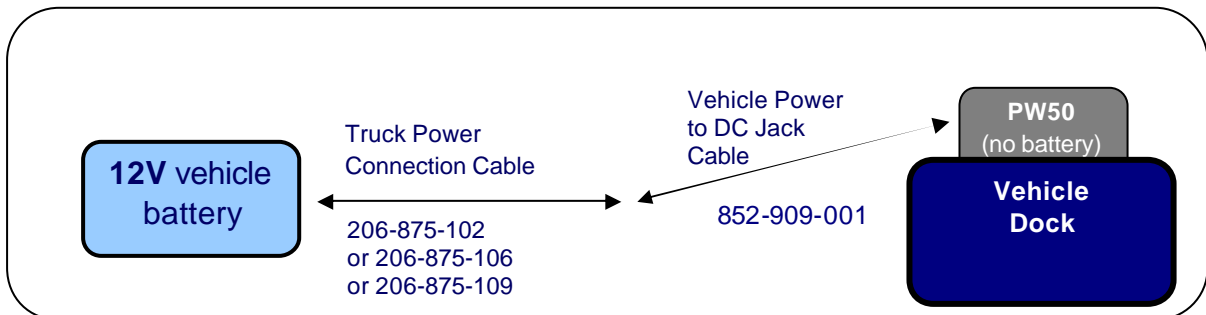

Forklift Mounting – Available Q2 2008



(typical forklift installation uses 2 cables and DC/DC converter)

Note: Forklifts typically have very noisy electrical systems that need additional filtering (same as Intermec Handhelds)

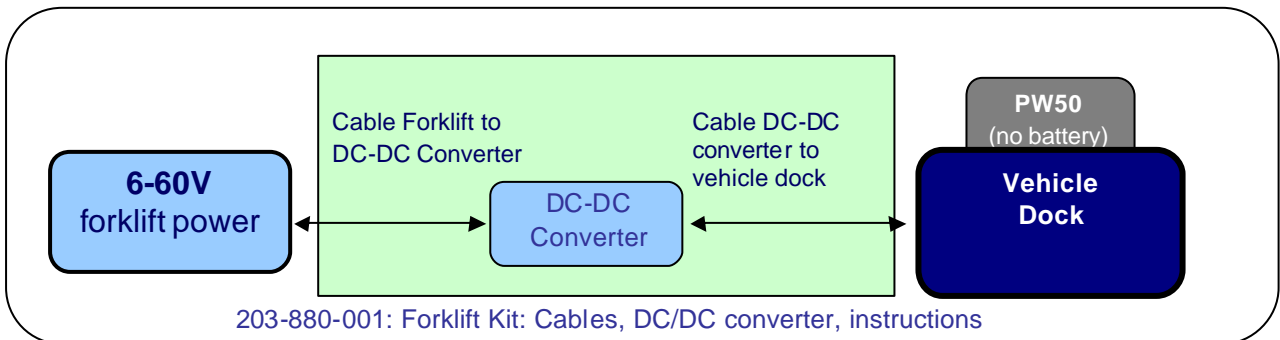
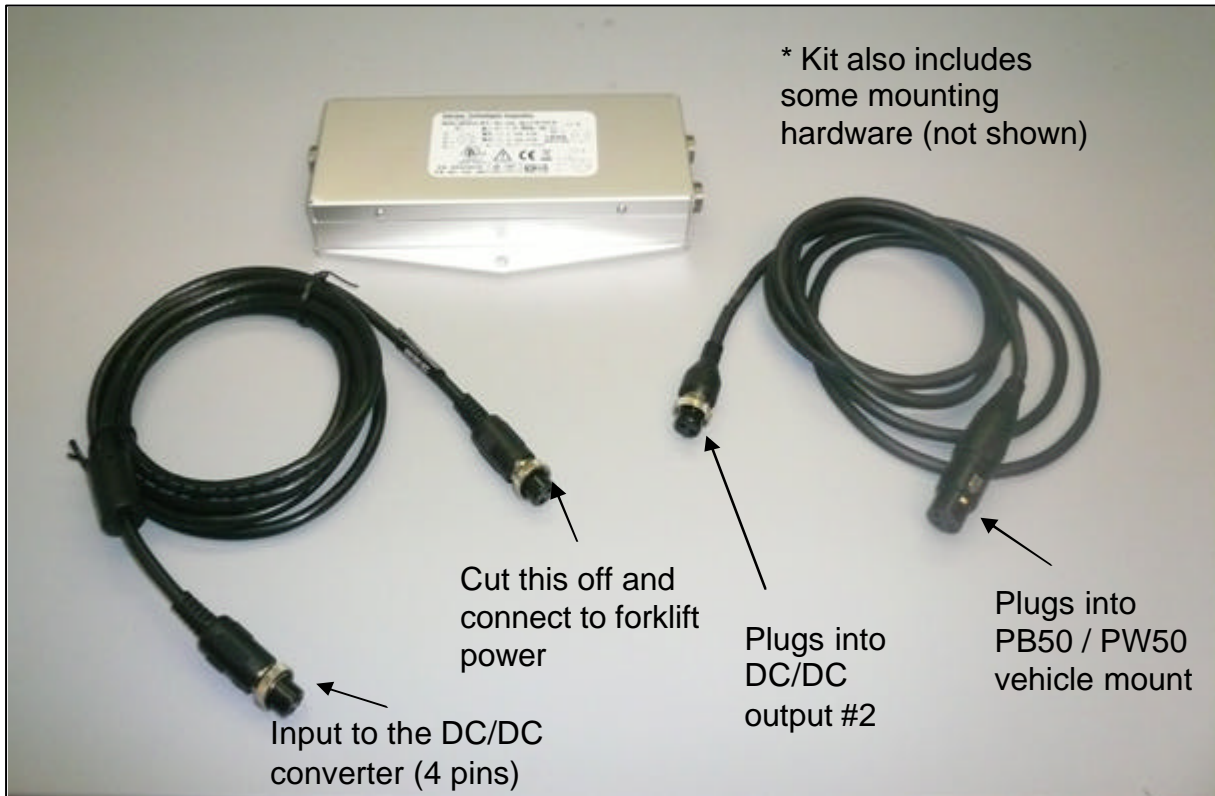
Name	Part Number	Description
Forklift Electrical Kit (See below)	203-880-001	Forklift Electrical Mounting Kit. Includes DC/DC Converter, Forklift to DC/DC Converter Cable, Vehicle Dock to DC/DC Converter Cable and Instructions.

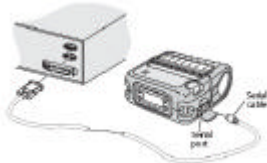
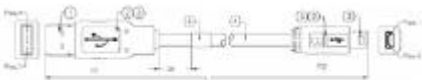
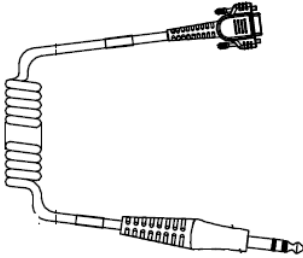

Communication and Media

Name	Part Number	Description
<p>Serial Communication Cable</p> 	<p>075497</p>	<p>Serial Data Cable, between PW50 and a RS232 host.</p> 
<p>USB Communication Cable</p> 	<p>321-611-102</p>	<p>Cable, USB-A to USB-Mini B plug, 2m. (PW50/PB50/PB42)</p>
<p>Dex Cable</p> 	<p>236-194-001</p>	<p>DEX Communication Cable</p> <p><i>Note: BDU and Pilot units (which were all built prior to April 2008) had a slightly different DEX connector on the PW50. This attachment screws were not long enough to keep the cable secured. This is fixed on production units (which started in early April 2008)</i></p>
<p>0.75" Media Core Kit</p> 	<p>320-377-001</p>	<p>Kit, 0.75" Media Core. PW50 Media Core Size Converting Kit. Shipped as standard.</p>
<p>0.4" Media Core Kit</p> 	<p>320-376-001</p>	<p>Kit, 0.4" Media Core. PW50 Media Core Size Converting Kit. Must be ordered as an accessory.</p>